

FAG

6008-H-2RSR

Deep groove ball bearing

Schaeffler ID:
0938809440000Deep groove ball bearing 60..-H-2RSR,
single row, H-Series, seals, steel sheet
metal cage

Technical information

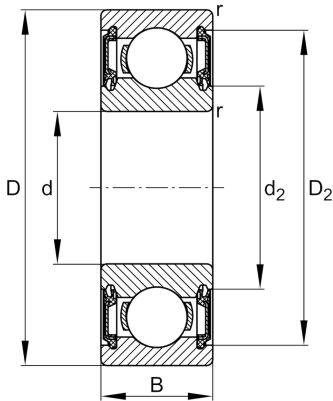
**Main Dimensions & Performance Data**

d	40 mm	Bore diameter
D	68 mm	Outside diameter
B	15 mm	Width
C_r	16.780 N	Basic dynamic load rating, radial
C_{0r}	11.540 N	Basic static load rating, radial
C_{ur}	690 N	Fatigue load limit, radial
n_G	5.500 1/min	Limiting speed
	0,2 kg	Weight

Dimensions

r_{min}	1 mm	Minimum chamfer dimension
D_2	61,4 mm	Caliber diameter outer ring
d_2	47,2 mm	Caliber diameter inner ring

Mounting dimensions

$d_{a min}$	44,6 mm	Minimum diameter shaft shoulder
$D_{a max}$	63,4 mm	Maximum diameter of housing shoulder
$r_{a max}$	1 mm	Maximum fillet radius

Calculation factors

f_0	15,3	Calculation factor
-------	------	--------------------

Temperature range

T_{min}	-20 °C	Operating temperature min.
T_{max}	100 °C	Operating temperature max.

